

Owner's Manual — Phoenix R200 LGR Dehumidifier

Installation, Operation & Service Instructions

Read and Save These Instructions

The Phoenix R200 is a compact, energy efficient LGR dehumidifier that removes 125 pints per day (AHAM) while drawing only 8.3 amps of electricity. The R200 outperforms larger competitive dehumidifiers by removing more water, providing larger grain depression and consuming less power. The proven LGR design is surrounded by a durable roto-molded high impact plastic to create a dehumidifier that is smaller and lighter than competitive units.

In addition to the performance benefits and compact size, the R200 has patented bypass technology, increased airflow, multiple ducting options, and a pleated media filter. The R200 is the latest member of the Phoenix line of LGR dehumidifiers; the most effective and versatile drying devices made.

The Phoenix R200 LGR Dehumidifier

Patented Bypass Technology - Increased performance over a wide temperature range.

R-410A Refrigerant - The Phoenix R200 comes charged with R-410A refrigerant.

Capacity - The Phoenix R200 removes 125 pints per day at AHAM (80°F/60%RH).

Energy Efficiency - Draws only 8.3 amps and removes 5.2 pints/kWh.

Compact Design - Smaller, 20"x20"x33.5", and only 105 lbs.

Motorized Impeller - 325 CFM; Faster drying and superior static pressure for ducting.

More Grain Depression - Drier air from an LGR finishes jobs quicker versus a conventional refrigerant dehumidifier.

Focused Airflow - Patent focused outlet directs air downward across the wet surface.

Multiple Ducting Options - 12" intake, 10" exhaust.

Plastic Housing - Rugged roto-molded housing.

Solid State Controls - Easy to read and operate.

Protected Condensate Hose - Located under the top cover. Quick connect, cannot catch or be damaged on obstructions.

Telescoping Handle - A heavy-duty retractable handle for ease of transport and reduces space for storage and stacking.

Recessed 12" Wheels - Allows greater maneuverability on the job site and efficient storage. Rolls over obstacles with ease.

Pleated Media Air Filter - A 12"x12"x1" MERV-11 filter is standard.

Stacking/Nesting - Reduces space for ease of stacking and storage.

Patented
BYPASS
TECHNOLOGY



Phoenix R200
Part No. 4027000
Patent 7,246,503

TS-391
08/14

Specifications subject to change without notice.

Table of Contents

Introduction	1
1. Safety Certifications	2
2. Specifications	2
3. Operation	2
3.1 Transporting	2
3.2 Electrical Requirements	2
3.3 Condensate Removal	3
3.4 Ducting	3
3.5 Defrost Cycle	3
3.6 Power Button	3
3.7 Purge Button	3
3.8 Hour Meter	3
3.9 Hours Button	3
3.10 Defrost Light	4
3.11 Bypass Control	4
4. Maintenance	4
4.1 Air Filter	4
4.2 Storage	4
5. Service	4
5.1 Technical Description	4
5.2 Troubleshooting	5
5.3 Air Mover	6
5.4 Thermistor	6
5.5 Condensate Pump	6
5.6 Float Safety Switch	6
6. Options & Accessories	7
7. Wiring Diagram	7
8. Service Parts	8
9. Warranty	9

Read the operation and maintenance instructions carefully before using this unit. Proper adherence to these instructions is essential to obtain maximum benefit from your Phoenix R200 dehumidifier.

! WARNING

- It is designed to be used **INDOORS ONLY**.
- If used in a wet area, plug it into a **GROUND FAULT INTERRUPTER**.
- **DO NOT** use the Phoenix R200 as a bench or table.
- It must always be used in the upright position.

1 Safety Certifications

The Phoenix R200 conforms to standards ANSI/UL 474 and CSA C22.2 No.92.

2 Specifications

Part No.	4027000
Power	8.3 amps, 120 VAC, Grounded
Water Removal	125 pints/day @ AHAM (80°F, 60%) 26 gal/day maximum @ saturation
Blower	325 CFM without external ducting 300 CFM @ .15 IWG external static
Refrigerant Charge	1 lb, 10 oz. R-410A
Operating Range	33°F to 110°F
Filters:	12" x 12" x 1" Pleated Media MERV-11
Duct Options	Intake – 12" Flex-Duct Outlet – 10" Lay-Flat
Warranty	Five years; 1st year 100% of Parts and Labor 2nd-5th year 100% of sealed refrigeration system parts.

Dimensions

	Unit	Shipping
Width	20"	21"
Height	33.5"	35.25"
Depth	20"	21"
Weight	105 lbs	115 lbs

Patent - 7,246,503

3 Operation

Place dehumidifier inside structure, place condensate hose into a drain, or a large water tight container, and turn on. To decrease drying times, make sure all windows and doors are closed to the outside and seal off the affected wet areas from unaffected areas.

Optimum performance will be observed between the temperatures of 70°F and 95°F.



Figure 1: Stacked Phoenix R200

3.1 Transporting

The Phoenix R200 features a high impact roto-molded housing with 12" recessed wheels and a telescoping handle. The rugged roto-molded housing protects the dehumidifier from damage. The 12" wheels provide greater maneuverability and roll over obstacles with ease. The telescoping handle and recessed wheels create a compact dehumidifier for improved storage and transport. To operate the telescoping handle, pull out the lever to release the lock and lift the handle until it

locks in the up position. Repeat to lock the handle in the down position. More compact storage can be achieved by stacking the units two high. The wheels of the unit 'nest' in the indentations of the bottom unit to provide stability, see figure 1. It is recommended the units are properly secured for transport. The Phoenix R200 must always be upright when transported by vehicle. It may be tipped onto its handle and back for loading and moving by hand.

3.2 Electrical Requirements

The Phoenix R200 plugs into a common grounded outlet on a 15 amp circuit. It draws 8.3 amps at 80°F, 60% RH. If used in a wet area, a ground fault interrupter (GFI) is required. If an extension cord is required, it must have a minimum of 14 gauge conductors if 25 feet long or less and 12 gauge conductors if greater than 25 feet long.

3.3 Condensate Removal

The Phoenix R200 is equipped with an internal condensate pump to remove the water that is condensed during dehumidification. This pump allows the condensate to be pumped 20 feet above the unit with the attached hose. If the condensate must be pumped more than 20 feet above the unit, a relay pump must be added. The condensate pump automatically purges for 20 seconds every eight minutes. Use the PURGE button to empty reservoir. If the condensate level rises in the reservoir to a critical level a back-up float switch will activate the pump-out for up to 1 minute. If the water in the reservoir fails to be evacuated, the safety switch will turn off the compressor.

3.4 Ducting

A wire duct collar is supplied to allow 10" lay-flat duct to be attached to the Phoenix R200 outlet. Lay-flat plastic ducting is available (see accessories in section 6). Attach ducting to the wire duct collar by inserting the plastic duct end through the collar center and rolling the duct end outward to overlap the outside of the collar. The duct and collar may then be quickly attached to the Phoenix R200 by snapping the collar over the four plastic exhaust tabs.

If the R200 is located in the unaffected area, the intake can be ducted with 1.2" flex duct (see accessories in section 6). Attach the flex duct to the top cover by hooking the spiral wire under the four tabs. Tape the duct to the top cover for a complete seal.

3.5 Defrost Cycle

If the low side refrigerant temperature drops below the defrost set point, due to excessive frost formation on the evaporator coil, the thermistor activates the solid-state control and the defrost light. The control cycles the compressor "off" and "on" by the thermistor temperature measurement. The air mover will continue to run, causing air to flow through the evaporator coil and melt the ice when



Figure 2: Phoenix R200 control board.

the compressor is off. When the air temperature and/or humidity increases, the evaporator temperature will rise and the thermistor will end the defrost cycle at the defrost set point.

3.6 POWER Button

Press the POWER button to turn the dehumidifier "on" or "off". When starting the dehumidifier the display will show the accumulated hours. Press the POWER button again to turn the dehumidifier off. The display will also power off.

3.7 PURGE Button

During normal operation the pump automatically cycles every four minutes. Press the PURGE button to remove condensate manually from the reservoir. There are three ways to manually remove water from the reservoir:

1. Press the PURGE button once and the pump will run for 20 seconds
2. Press and hold the PURGE button and the pump will run for up to 30 seconds
3. Press the PURGE button while the dehumidifier is plugged in but powered off and the pump will run for 30 seconds.

Always manually purge the water reservoir before transport or storage. Turn off the power and allow the plugged in dehumidifier to rest 15 minutes before the final purge.

3.8 Hour Meter

The digital hour meter displays the amount of time the dehumidifier has been turned on to the tenth of an hour. The hour meter continuously cycles between total machine hours and job hours every 3 seconds. Hours are stored in memory even when the unit is unplugged. The previous totals will be displayed next time the unit is powered on.

3.9 HOURS Button

Pressing the HOURS button displays the hour meter when the unit is turned off but plugged into power. To reset job hours, press and hold the HOURS button for 5 seconds when the unit is operating.

3.10 Defrost Light

The DEFROST light turns on when the unit is in defrost cycle and indicates when the compressor is off.

3.11 Bypass Control

Below 90°F - When the Phoenix R200 is used in normal dehumidifier operating temperatures (below 90°F), the bypass cover must close the bypass openings, figure 3. This maximizes performance by increasing the amount of air that is dehumidified across the evaporator. This temperature range is often found during the first 24 hours of a drying job.

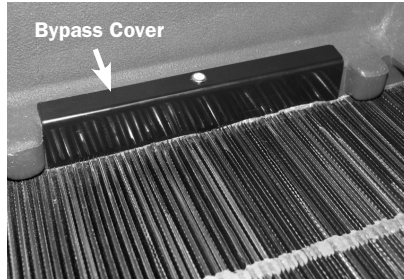

Figure 3

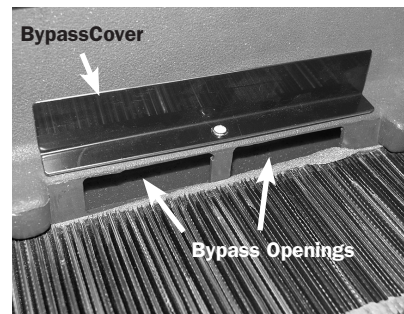
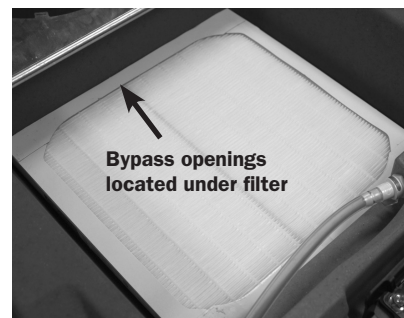

Figure 4

Above 90°F - When the Phoenix R200 is used in high temperature conditions above 90°F, reposition the bypass cover to open the bypass holes, figure 4. This improves dehumidifier efficiency by increasing the amount of airflow over the condenser and lowering the refrigerant pressure. Simultaneously, this slows the airflow across the evaporator allowing the air temperature to be lowered to the dew point and increases dehumidifier capacity. These higher temperatures are often found after the first 24 hours.



Remove filter, snap grain control cover into position shown, and replace filter.

4 Maintenance

4.1 Air Filter

The Phoenix R200 is equipped with a pleated media air filter that must be checked regularly. The standard filter is a MERV-11 high efficiency filter. Operating the unit with a dirty filter will reduce the dehumidifier's capacity and efficiency and may force the unit into defrost causing the compressor to cycle "off" and "on" unnecessarily.

The filter can generally be vacuumed clean several times before needing replacement. Replacement filters can be ordered from the manufacturer or purchased locally if available.

! IMPORTANT

IMPORTANT: DO NOT operate the unit without the filter or with a less effective filter as the heat exchanger and coils inside the unit could become clogged and require disassembly to clean.

4.2 Storage

There are two issues to consider when the Phoenix R200 is stored between uses and both pertain to the water trapped in the unit: damage caused by freezing or biological growth. The effect of the trapped water can be greatly reduced if precautions are taken to remove as much as possible before storage.

1. Use the pump PURGE button to reduce the water level in the reservoir
2. Walk out the hose to drain it completely

In order to reduce biological growth flush the unit with a biofungicide that is approved for use with copper, aluminum, polyethylene and ABS. To flush:

1. Run the hose to a drain
2. Plug in the unit but do not turn it on
3. Remove the air filter. Slowly pour a pint of the chemical through the top so that it drains into the heat exchanger
4. Use PURGE button to remove chemicals in reservoir. Run PURGE until hose runs dry
5. Walk out hose to drain completely
6. Replace air filter

5 Service

! WARNING

WARNING: Servicing the Phoenix R200 with its high pressure refrigerant system and high voltage circuitry presents a health hazard which could result in death, serious bodily injury, and/or property damage. Only qualified service people should service this unit.

! CAUTION

CAUTION: Do not operate unit without the front housing in place.

5.1 Technical Description

The Phoenix R200 uses a refrigeration system similar to an air conditioner's to remove heat and moisture from incoming air and to add heat to the air that is discharged.

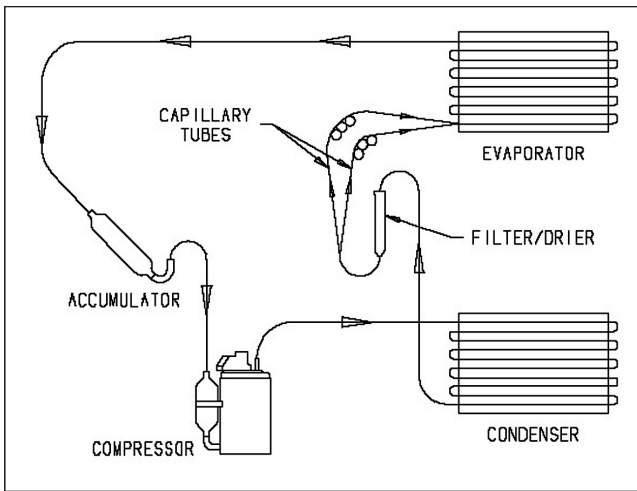

Figure 5: Refrigeration system

Hot, high pressure refrigerant gas is routed from the compressor to the condenser coil. The refrigerant is cooled and condensed by giving up its heat to the air that is about to be discharged from the unit. The refrigerant liquid then passes through a filter/drier and capillary tubing which cause the refrigerant pressure and temperature to drop. It next enters the evaporator coil where it absorbs heat from the incoming air and evaporates.

The evaporator operates in a flooded condition, which means that all the evaporator tubes contain liquid refrigerant during normal operation. A flooded evaporator should maintain constant pressure and temperature across the entire coil, from inlet to outlet.

The mixture of gas and liquid refrigerant enter the accumulator after leaving the evaporator coil. The accumulator prevents any liquid refrigerant from reaching the compressor. The compressor evacuates the cool refrigerant gas from the accumulator and compresses it to a high pressure and temperature to repeat the process.

5.2 Troubleshooting

No dehumidification, neither hour meter display nor compressor run and POWER button does not turn ON.

1. Unit unplugged or no power to outlet
2. Defective control board
3. Loose connection in internal wiring

No dehumidification, neither hour meter display nor compressor run with POWER button ON.

1. Defective control board
2. Loose connection in internal wiring

Some dehumidification, air mover runs continuously but compressor only runs sporadically.

1. Unit is in defrost cycle, DEFROST light on
2. Defrost thermistor defective or loose

3. Loose connection in compressor circuit
4. Defective compressor overload
5. Defective compressor
6. Defective relay
7. Upper housing is not sealed to lower housing

No dehumidification, air mover runs but compressor does not.

1. Bad connection in compressor circuit
2. Safety float switch closed, check pump reservoir
3. Defective compressor capacitor
4. Defective compressor overload
5. Defective compressor
6. Defective control board

Air mover does not run. Compressor runs briefly but cycles on and off.

1. Loose connection in blower circuit
2. Obstruction prevents impeller rotation
3. Defective air mover

Unit removes some water but not as much as expected.

1. Air temperature and/or humidity have dropped
2. Humidity meter and/or thermometer used are out of calibration
3. Unit has entered defrost cycle
4. Air filter dirty
5. Defective defrost thermistor
6. Low refrigerant charge
7. Air leak such as loose cover
8. Defective compressor
9. Restrictive exhaust or inlet ducting

Unit runs but does not pump water.

1. Hose kinked or plugged
2. Pump motor defective
3. Pump check valve plugged
4. Bad connection in pump circuit
5. Hose disconnected internally
6. Defective control board (pump phase)

Unit pumps water automatically but not when PURGE button is pushed.

1. Bad connection in PURGE button circuit
2. Defective control board

Evaporator coil frosted continuously, low dehumidifying capacity.

1. Defrost thermistor loose or defective
2. Low refrigerant charge
3. Dirty air filter or restricted air flow
4. Upper housing is not sealed to lower housing

Compressor runs with POWER button OFF.

1. Defective relay
2. Defective control board
3. Upper housing not sealed to tower

5.3 Air Mover

The motorized impeller has a PSC motor and internal thermal overload protection. If defective, the complete assembly must be replaced.

1. Unplug power cord
2. Remove the four screws attaching the bottom plate to the lower housing
3. Disconnect the impeller leads
4. Remove the four screws holding the impeller to the bottom plate
5. Reassemble the new impeller using the above procedure in reverse

5.4 Thermistor

The defrost thermistor is attached to the refrigerant suction line between the accumulator and the evaporator.

To replace thermistor:

1. Unplug the dehumidifier
2. Remove the front housing
3. Cut cable ties and remove insulation and aluminum tape.
4. Remove control panel
5. Unthread thermistor from control housing grommet
6. Detach thermistor from control board jumper
7. Reassemble thermistor and dehumidifier using the above procedure in reverse



Figure 6: Thermistor attached to the refrigerant line.

5.5 Condensate Pump

The internal condensate pump removes water that collects in the reservoir.

To replace the condensate pump:

1. Unplug the unit
2. Remove the front housing
3. Unplug the pump wires from the wire harness
4. Remove the condensate hose and the one screw attaching the pump bracket to the compressor support
5. Replace the pump, hose, wiring, bolts, and housing in the reverse order

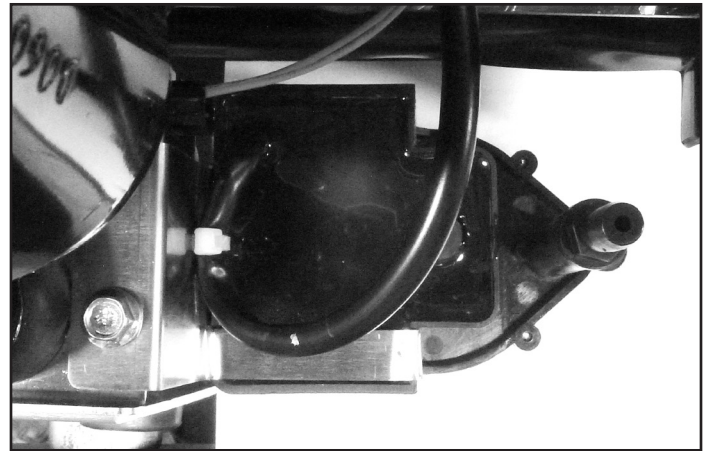

Figure 7: Picture of pump and float switch brackets screw.

5.6 Float Safety Switch

The float safety switch activates when the water rises too high in the condensate reservoir. The float safety switch turns off the compressor until the water level lowers and disengages the switch.

To replace the float safety switch

1. Unplug the dehumidifier
2. Remove the front housing
3. Unplug the float safety switch wires from the wire harness
4. Remove the one screw attaching the pump and float switch bracket to the compressor support
5. Remove the pump from the reservoir and slide out the float switch from under the compressor support
6. Replace the float, pump, wiring, bolts and housing in the reverse order

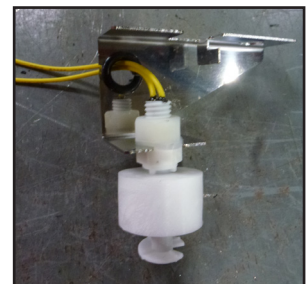

Figure 8: Picture of the float safety switch.

6 Options & Accessories

- 4024750 Intake Flex Duct 12" x 25"
Metallize Polyester
- 4024935 Lay-Flat Duct 10" Round x 250' Roll

To order, contact Therma-Stor LLC at 1-800-533-7533.

7 Wiring Diagram

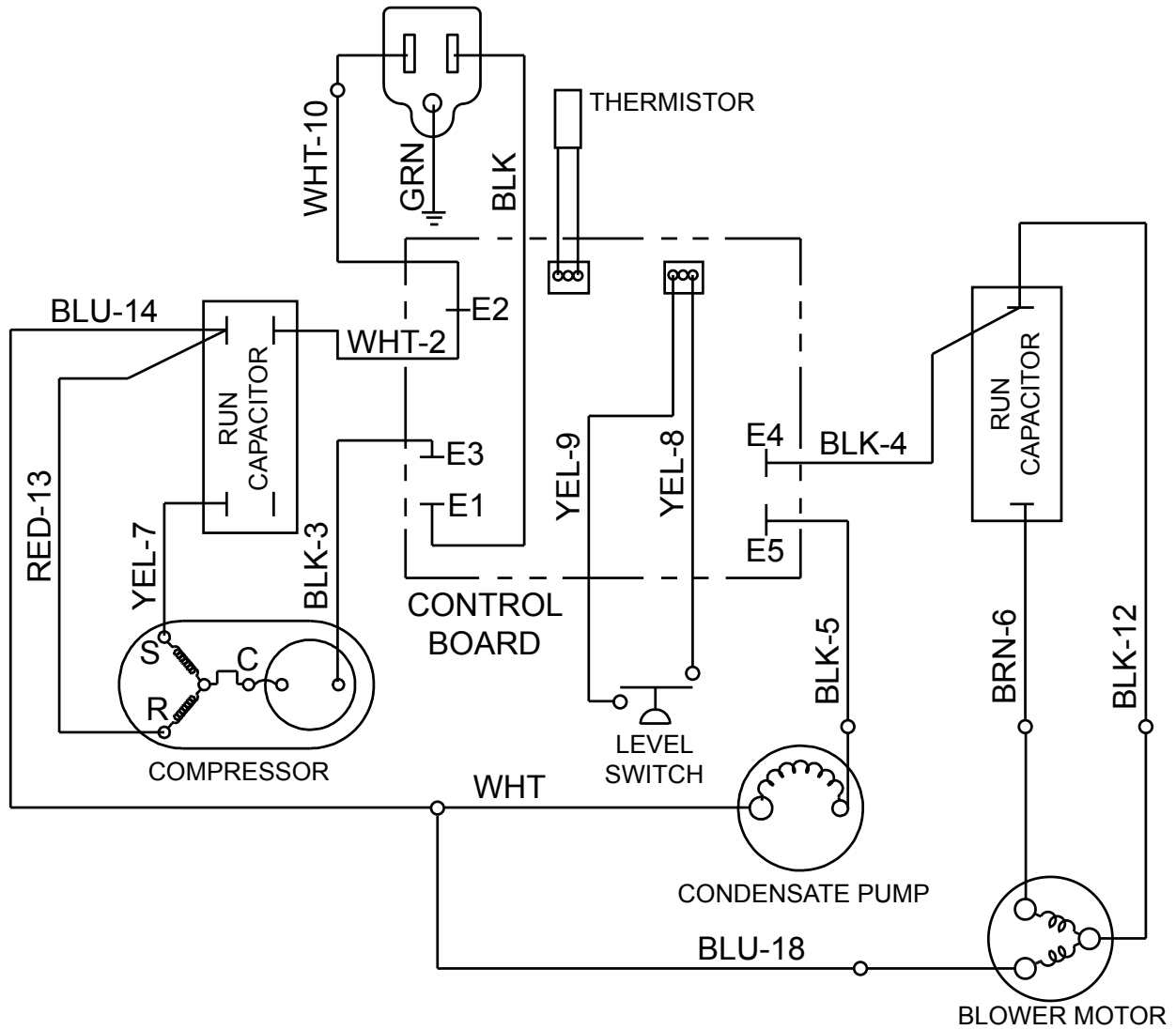

Figure 9: Wiring diagram

8 Service Parts

Item	Description	Qty	Part No.	Item	Description	Qty	Part No.
1	Top Cover	1	4026977	11	Coupling Body, 1/4" Tube	1	4026306
2	Top Cover Catch	1	4026979	12	Coupling Insert, 1/4" Tube	1	4026986
3	Top Cover Hinge	2	4026978	13	Cord	1	4032315
4	Hex Bolts, 1/4"-20 x 4" 4	1	1154019	14	Control Board	1	4026763
5	Hex Bolts, 1/4"-20 x 1.75"	2	1154014	15	Capacitor, Compressor, 45 µF	1	4033032-05
6	Handle Weldment	1	4026344	16	Capacitor, Impeller, 15 µF	1	4033031-07
7	Wheel, 12"	2	4026851	17	Thermistor	1	4031279
8	Cotter Pin	2	1284404	18	Handle lever	1	4026350
9	Filter, 12" x 12" x 1"	1	4025568				
10	Hose (1/4" ID x 33' long)	1	4024916				

Items listed are not shown

Description	Qty	Part No.	Description	Qty	Part No.
Compressor	1	4029190	Float Safety Switch	1	4034374
Evaporator Coil	1	4026985	Impeller, Air Mover	1	4026657
Condenser Coil	1	4026983	Exhaust Grill	1	4026308
Accumulator	1	4028297	Wire Duct Collar	1	4026309
Condensate Pump	1	4034832	Impeller Plate Bolt	4	1154006



Specifications subject to change without notice.

Phoenix R200 Dehumidifier Limited Warranty

Warrantor:

Therma-Stor LLC
4201 Lien Rd.
Madison, WI 53704
Telephone: 1-800-533-7533

Who Is Covered: This warranty extends only to the original end-user of the Phoenix R200 dehumidifier and may not be assigned or transferred.

Year One: Therma-Stor LLC warrants that, for one (1) year the Phoenix R200 dehumidifier will operate free from any defects in materials and workmanship, or Therma-Stor LLC will, at its option, repair or replace the defective part(s), free of any charge.

Year(s) Two Through Five: Therma-Stor LLC further warrants that for a period of five (5) years, the condenser, evaporator, and compressor of the Phoenix R200 dehumidifier will operate free of any defects in material or workmanship, or Therma-Stor LLC, at its option, will repair or replace the defective part(s), provided that all labor and transportation charges for the part(s) shall be borne by the end-user.

Year(s) One Through Seven: Materials and workmanship of the housing are covered.

End-User Responsibilities: Warranty service must be performed by a Servicer authorized by Therma-Stor LLC. If the end-user is unable to locate or obtain warranty service from an authorized Servicer, he should call Therma-Stor LLC at the above number and ask for the Therma-Stor Service Department, which will then arrange for covered warranty service. Warranty service will be performed during normal working hours.

The end-user must present proof of purchase (lease) upon request, by use of the warranty card or other reasonable and reliable means. The end-user is responsible for normal care. This warranty does not cover any defect, malfunction, etc. resulting from misuse, abuse, lack of normal care, corrosion, freezing, tampering, modification, unauthorized or improper repair or installation, accident, acts of nature or any other cause beyond Therma-Stor LLC's reasonable control.

Limitation and Exclusions: If any Phoenix R200 Dehumidifier part is repaired or replaced, the new part shall be warranted for only the remainder of the original warranty period applicable thereto (but all warranty periods will be extended by the period of time, if any, that the Phoenix R200 Dehumidifier is out of service while awaiting covered warranty service).

UPON THE EXPIRATION OF THE WRITTEN WARRANTY APPLICABLE TO THE PHOENIX R200 DEHUMIDIFIER OR ANY PART THEREOF, ALL OTHER WARRANTIES IMPLIED BY LAW, INCLUDING MERCHANTABILITY AND FITNESS FOR A PARTICULAR PURPOSE, SHALL ALSO EXPIRE. ALL WARRANTIES MADE BY THERMA-STOR LLC ARE SET FORTH HEREIN, AND NO CLAIM MAY BE MADE AGAINST THERMA-STOR LLC BASED ON ANY ORAL WARRANTY. IN NO EVENT SHALL THERMA-STOR LLC, IN CONNECTION WITH THE SALE, INSTALLATION, USE, REPAIR OR REPLACEMENT OF ANY PHOENIX R200 DEHUMIDIFIER OR PART THEREOF BE LIABLE UNDER ANY LEGAL THEORY FOR ANY SPECIAL, INDIRECT OR CONSEQUENTIAL DAMAGES INCLUDING WITHOUT LIMITATION WATER DAMAGE (THE END-USER SHOULD TAKE PRECAUTIONS AGAINST SAME), LOST PROFITS, DELAY, OR LOSS OF USE OR DAMAGE TO ANY REAL OR PERSONAL PROPERTY.

Some states do not allow limitations on how long an implied warranty lasts, and some do not allow the exclusion or limitation of incidental or consequential damages, so one or both of these limitations may not apply to you.

Legal Rights: This warranty gives you specific legal rights, and you may also have other rights which vary from state to state.

